

CL-50 MOUNTING KIT FOR J275-D ONLY

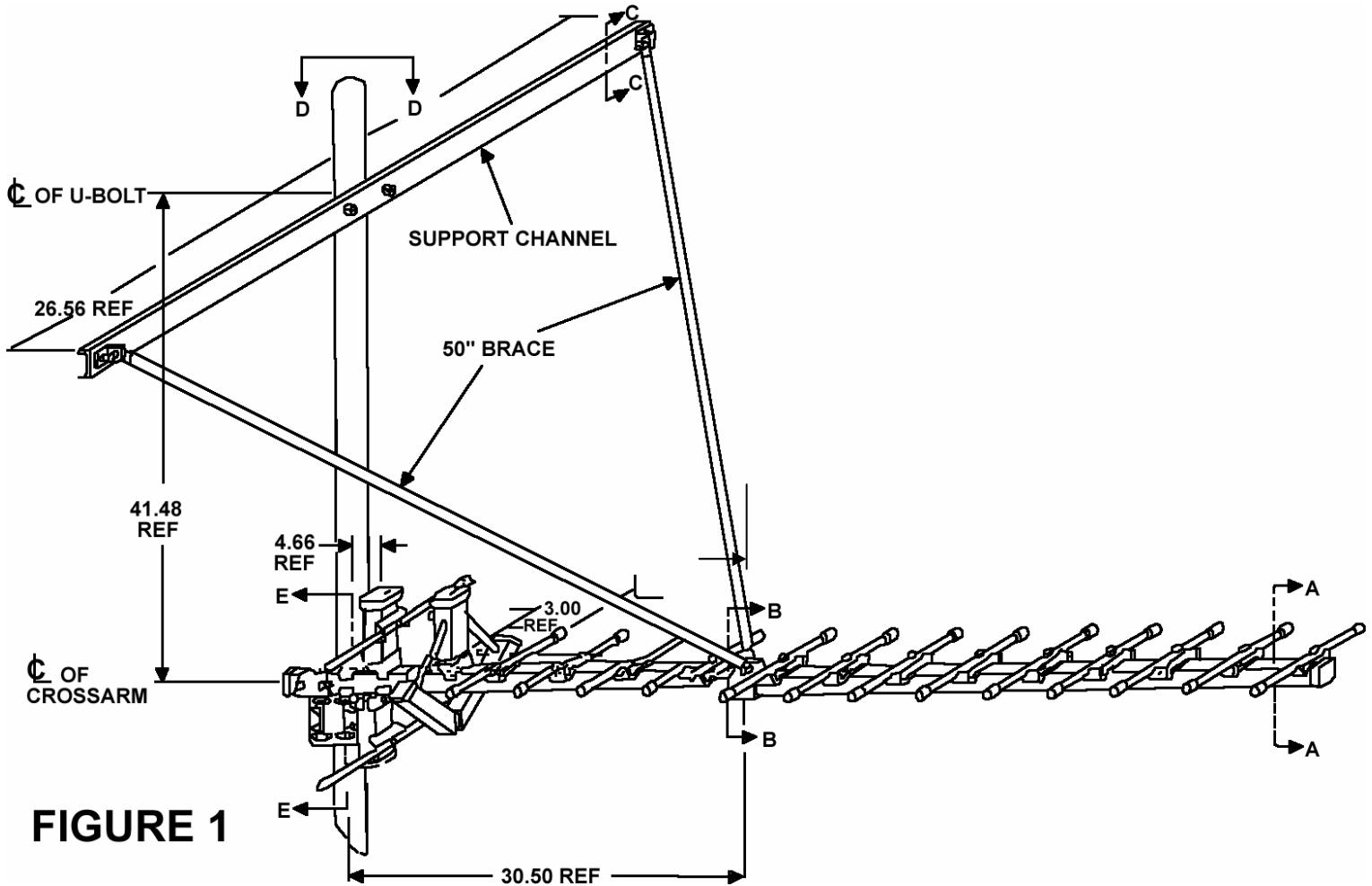

ASSEMBLY:

1. ATTACH THE CLAMP BRACKETS AS SHOWN IN SECTION B-B.
2. ATTACH CANTILEVER BRACES AND SUPPORT CHANNEL TO ANTENNA ASSEMBLY AS SHOWN IN SECTION B-B & SECTION C-C.











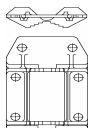

MOUNTING:

1. LIFT THE ANTENNA ASSEMBLY INTO POSITION, ORIENT IN THE DESIRED DIRECTION AND LIGHTLY SECURE TO THE MAST WITH SUPPLIED U-BOLTS, WASHERS AND NUTS. LIGHTLY SECURE SUPPORT CHANNEL ABOVE CROSSARM AS SHOWN IN FIGURE 1.
2. RUN THE DOWN LEAD TO THE "HEAD-END" OR DISTRIBUTION EQUIPMENT ACCORDING TO STANDARD PRACTICE, USING TAPE AND APPROPRIATE INSULATED STAPLES AS REQUIRED. APPLY APPROPRIATE WEATHERPROOFING.

FINAL ORIENTATION:

ROTATE THE ANTENNA UNTIL MAXIMUM SIGNAL STRENGTH IS RECEIVED, THEN FULLY SECURE THE U-BOLTS TO THE MAST.

PARTS LIST

	PART NO.	DESCRIPTION	QUANTITY
	27766-004	Mounting Bracket	1
	20041-001	U-Bolt, 3/8"-16 X 3.10" ID	3
	29017-001	Clamp Bracket	2
	27781-001	Reinforcing Channel	1
	29016-001	Angle Bracket	2
	32432030	3/8-16 x 2 1/4" HEX HD CAP	5
	32431960	3/8-16 x 1 1/4" HEX HD CAP	6
	37134550	WASHER, FLAT (3/8") 1" x 25/64 x .062	9
	37434320	LOCKWASHER, 3/8" SPLIT	16
	36531540	NUT, 3/8-16 HEX	16
	3390-008	BRACE, 50"	2
	29018-002	SUPPORT CHANNEL	1

